

FORTE-4 NB

FLOOD LIGHT



Areas of application

- Construction Sites
- Stadiums
- Facades
- Parking Spaces
- Closed Spor Complexes
- Building Surroundings

Product benefits

- Efficient energy saving
- Elegant design
- Easy installation system

Product specifications

- Lifetime (L70/B50) : up to 50,000 h
- Color temperature : 2,700 K - 6,500 K
- Operating voltage : 220...240 V AC supply
- Type of protection : IP67
- Surfaced mounting
- Led type : Samsung - Cree
- Driver : Meanwell - Inventronics



IP 67



Product datasheet

Technical data

Electrical data

Nominal wattage	220W - 300W
Nominal voltage	220 - 240 V
Power factor	> 0.9
Lumen / Watt	110 lm/watt - 103 lm/watt
Total harmonic distortion	< %20
Mains frequency	50...60 Hz

Photometrical data

Color temperature	2700 K - 6500 K
Luminous flux	24235 lm - 30967 lm
Color rendering index Ra	> 80

Dimensions

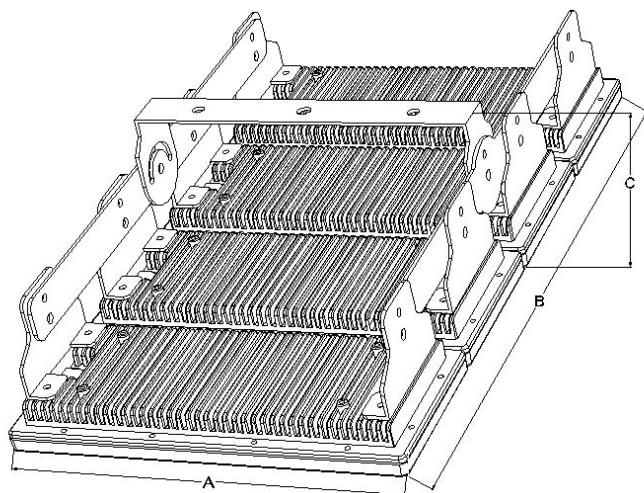

A	350 mm
B	600 mm
C	150 mm

Colors & materials

Body material	Aluminum die cast
Product color	Electrostatic powder paint

Note : Product body paint can be ordered with other RAL codes.

Temperatures & operating conditions

Ambient temperature range	-25 ... +85 °C
---------------------------	----------------

Product datasheet

Light Technical Data

Beam angle	Narrow distribution
------------	---------------------

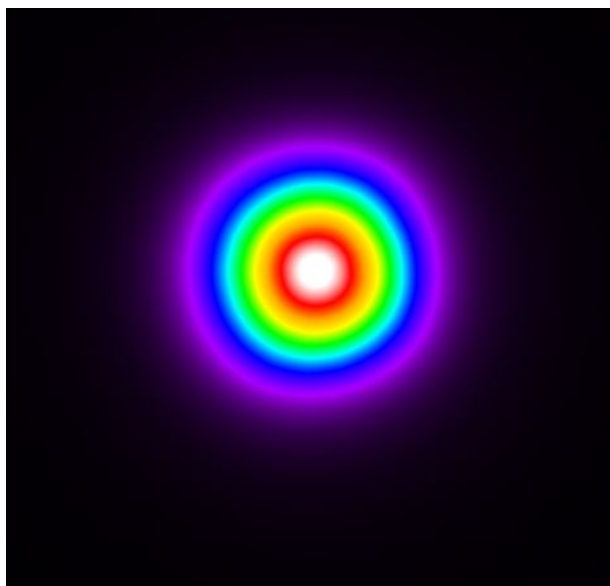
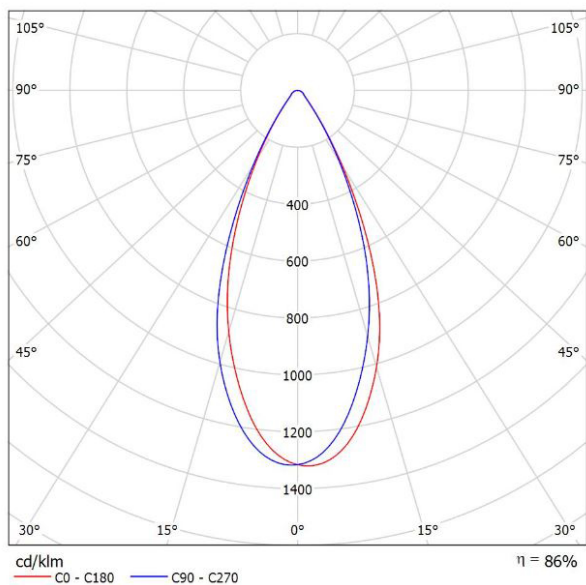

Type of cover	Solid PC
---------------	----------

Capabilities

Type of installation	Surfaced
Type of connection	Cable, 3 x 1.50 mm ²

Certificates & standards

Protection class	Insulation class I (safety insulation)
Type of protection	IP67